

# Simple Rabbit / Simple Lapin

Designed and diagrammed by Naoki Terao /  
Créé et diagrammé par Naoki Terao

Paper / Papier:

- Kami 15 x 15 cm

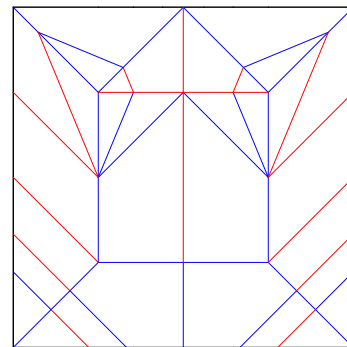
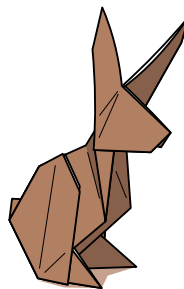

## About / A propos :

I designed this model for a beginner class just before Easter in 2024. I generally don't create simple models, but creating an easy model made me focus on the general structure and not the details. I learned that it is better to have a good structure than a lot of details that waste paper.

*Ce modèle a été créé pour un cours d'origami pour débutants juste avant Pâques en 2024. Généralement, je ne crée pas de modèles simples, mais créer un modèle facile m'a permis de me concentrer sur la structure générale du modèle et non pas sur les détails. J'ai appris qu'il est préférable d'avoir une bonne structure que beaucoup de détails qui gaspillent du papier.*

 The brown side will be the color of the model /  
Le côté brun sera la couleur du modèle

**1**

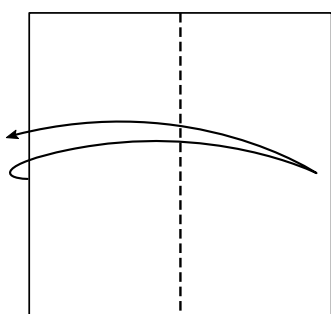

Fold in half and unfold /  
Plier en deux et déplier

**2**

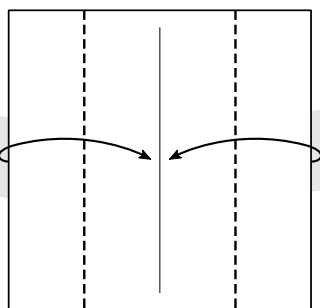

Fold the edges to the crease line /  
Plier les bords sur le pli central

**3**

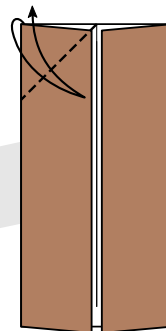

Fold the top edge to the center crease and unfold /  
Plier le bord du haut sur le pli central et déplier

**4**

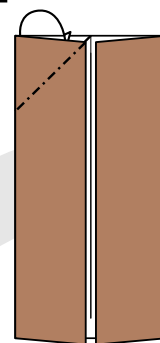

Inside reverse the fold /  
Inverser le pli vers l'intérieur

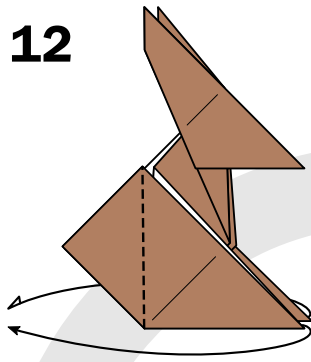

**12**

Fold the flap to the left and repeat behind / *Plier le volet vers la gauche et répéter derrière*

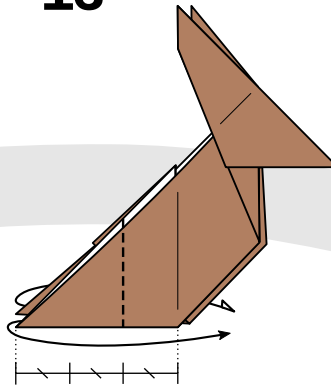
**13**

Fold the flap at 1/3 to the right and repeat on the other side / *Plier le volet au tiers vers la droite et répéter de l'autre côté*

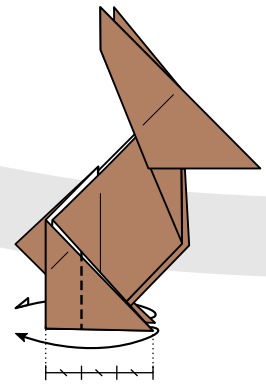
**14**

Fold the flap at 1/3 to the left and repeat behind / *Plier le volet au tiers vers la gauche et répéter derrière*

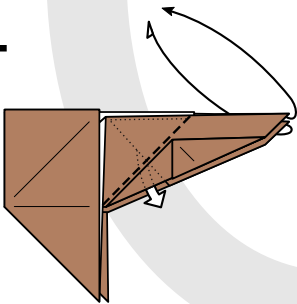
**11**

Fold upwards and release the inner flap downwards / *Plier vers le haut et libérer le volet intérieur vers le bas*

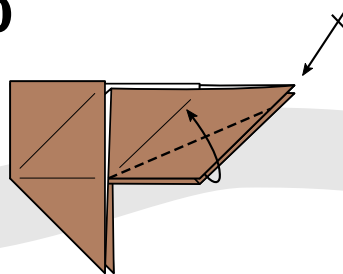
**10**

Fold an angle bisector to the crease line. Repeat on the other side / *Plier la bissectrice jusqu'au pli. Répéter de l'autre côté*

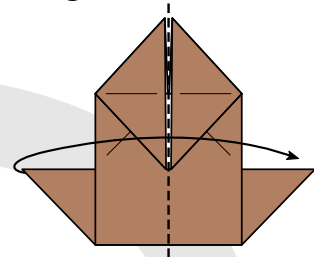
**9**

Fold the model in half / *Plier le modèle en deux*

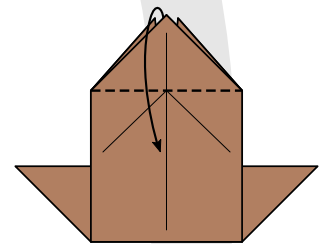
**8**

Fold the flap downward / *Plier le volet vers le bas*

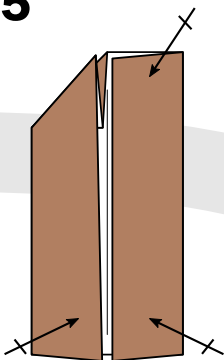
**5**

Repeat steps 3 and 4 on the other 3 corners / *Répéter les étapes 3 et 4 sur les 3 autres coins*

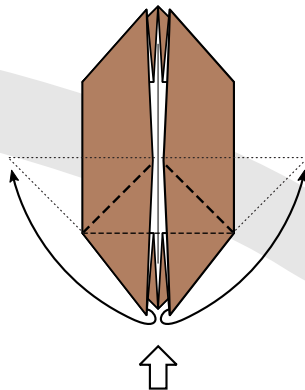
**6**

Fold the corners up and to the sides / *Plier les coins vers le haut et sur les côtés*

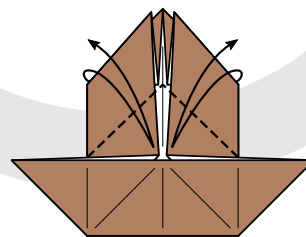
**7**

Fold the corners to the center and unfold / *Plier les coins sur le centre et déplier*

15

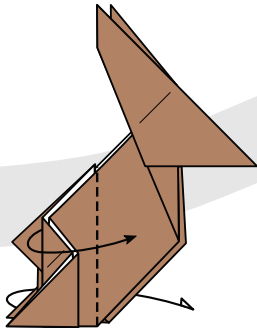

Fold the flap to the right and repeat behind / Plier le volet vers la droite et répéter derrière

16

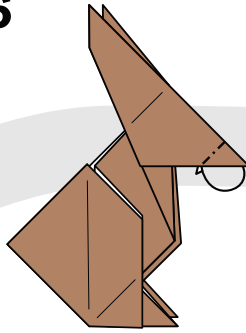

Fold the tip inside / Plier le bout à l'intérieur

17

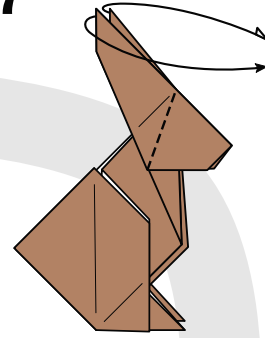

Fold the flaps to the right / Plier les volets vers la droite

18

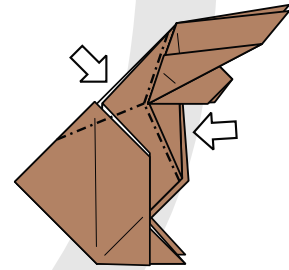

Make the body 3D / Mettre le corps en volume

19

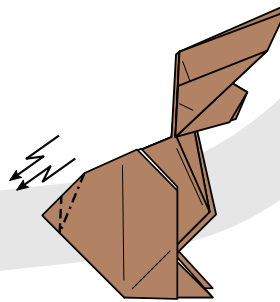

Crimp to form the tail / Replier pour former la queue

20

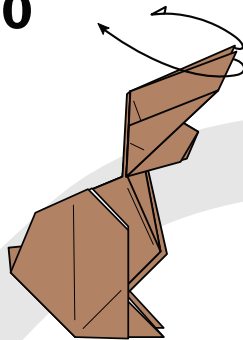

Shape the rabbit / Mettre en forme

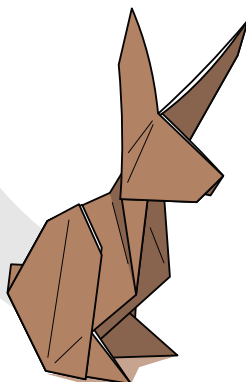

Finished Rabbit! / Le lapin est terminé!